

Adaptadores POL

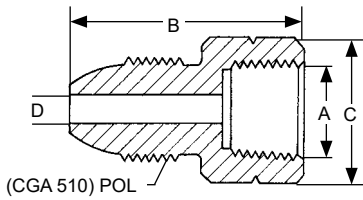

(CGA 510) POL

Macho POL x Hembra NPT

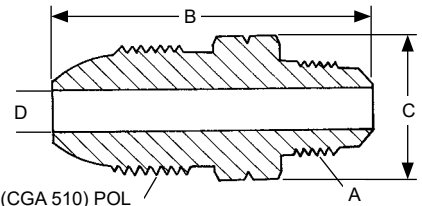

(CGA 510) POL

Macho POL x Macho NPT y Abocinado SAE

Información Para Ordenar Productos

Número de Parte	Material	A ACME M.	B	C Hexágono	D Diámetro
2906A	Latón	1/4"	1 3/8"	"	1/4"
2906G		1/2"	2"	1 1/8"	

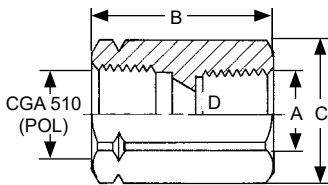

Hembra POL x Hembra NPT y POL Hembra

Información Para Ordenar Productos

Número de Parte	Material	A	B	C Hexágono	D Diámetro
2906D	Latón	3/8" NPT M.	2"	"	"
2906F		3/8" Abocinado SAE		7/8"	"
2906E		1/2" Abocinado SAE	2 1/4"		

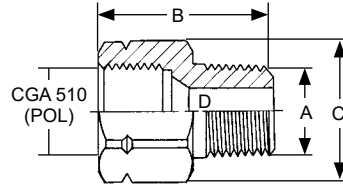

Hembra POL x Macho NPT

Información Para Ordenar Productos

Número de Parte	Material	A	B	C Hexágono	D Diámetro
5760Z	Latón	1/8"	1 5/8"	1 1/8"	3/16"
5760A		1/4"			13/32"
5760B		3/8"			35/64"
5760C		1/2"			43/64"
5760D		3/4"	1 1/8"	1 3/8"	13/32"
5760S	POL (CGA 510)	2 1/8"	1 1/8"		

Información Para Ordenar Productos

Número de Parte	Material	A	B	C Hex	D Diámetro
5761A	Latón	1/4"	1 5/8"	1 1/8"	3/16"
5761B		3/8"			13/32"
5761C		1/2"			7/16"
5761D		3/4"			

H

Adaptador de Manguera para gases combustible (Gas L F 1/4" Min Acetileno).

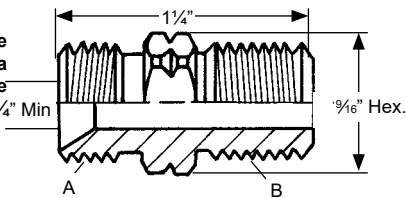

Información Para Ordenar Productos

Número de Parte	Material	A	B
15774-1	Latón	1/4" NPT M.	Aboc. Invertido Hembra

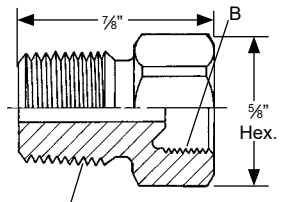

Abocinado Invertido Hembra x Macho NPT

Información Para Ordenar Productos

Número de Parte	Material	A	B
1300	Latón	"-18NF (L.H.)	1/4" NPT M.

Adaptador de Manómetro de Presión

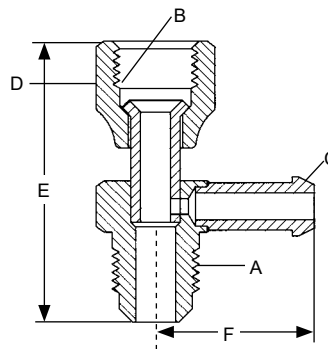
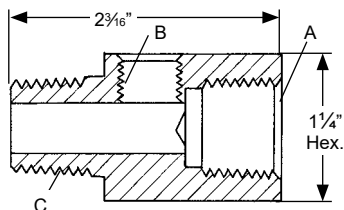

Información Para Ordenar Productos

Número de Parte	Material	A	B	C
1494-1	Latón	1/2" NPT F.	1/4" NPT F.	1/2" NPT M.

Información Para Ordenar Productos

No. de Parte	Material	A	B	C	D	E	F
1328	Latón	5/8" - 18 UNF	5/8" - 18 UNF	Conexión Dentada de 1/4"	13/16"	2"	1 1/2"
1331		3/4" - 16 UNF	3/4" - 16 UNF		15/16"	2 1/8"	1 1/4"
1332		7/8" - 14 UNF	7/8" - 14 UNF		1 1/16"	2 1/2"	